



**Sanpress Inox G XL-Bogen 45°
mit SC-Contur**

- Pressanschlüsse

Ausstattung

Dichtelemente HNBR, Schneidringe, Trennringe

Modell 0226XL

Artikel 578 268

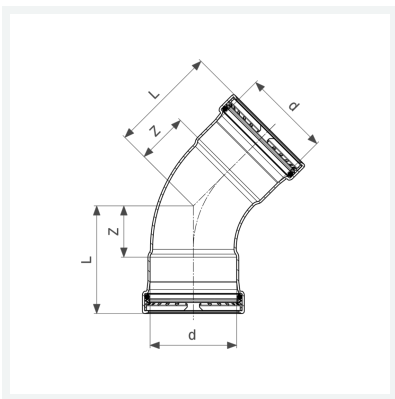

Eigenschaften

Rohraußendurchmesser	d	76,1
Z-Maß	Z	46 mm
Länge	L	96 mm
Gewicht	855 g	
Volumen	3108 cm ³	
Werkstoff	Stahl nichtrostend	